

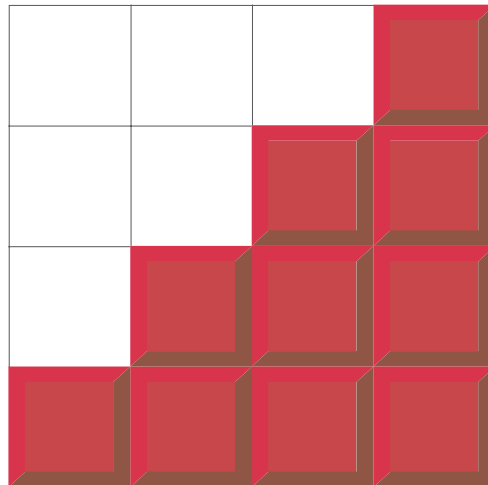

Matrix™ UPS

Models 3000 and 5000
208/220–240 Vac, 50/60 Hz version



User's
Manual



Important safety instructions!

Please read this manual!

Veillez lire ce manuel!

Bitte lesen Sie dieses Anleitungshandbuch!

¡Se ruega leer este manual de instrucciones!

This manual provides safety, installation, and operating instructions to help you get the fullest performance and service life that the UPS has to offer.

PLEASE SAVE THIS MANUAL ! It includes important instructions for the safe use of this UPS and for obtaining factory service should the proper operation of the UPS come into question. Down the road, service or storage issues may arise and require reference to this manual.

CONSERVER CES INSTRUCTIONS ! Cette notice contient des instructions importantes concernant la sécurité.



Radio frequency interference

WARNING: Changes or modifications to this unit not expressly approved by the party responsible for compliance could void the user's authority to operate the equipment.

NOTE: This equipment has been tested and found to comply with the limits for a Class A digital device pursuant to Part 15 of the FCC Rules. These limits are designed to provide reasonable protection against harmful interference when the equipment is operated in a commercial environment. This equipment generates, uses, and can radiate radio frequency energy and, if not installed and used in accordance with the instruction manual, may cause harmful interference to radio communications. Operation of this equipment in a residential area is likely to cause harmful interference in which case the user will be required to correct the interference at his own expense.

Shielded cables must be used with this unit to ensure compliance with the Class A FCC limits.

This digital apparatus does not exceed the Class A limits for radio noise emissions from digital apparatus set out in the Radio Interference Regulations of the Canadian Department of Communications.

Le présent appareil numérique n'émet pas de bruits radioélectriques dépassant les limites applicables aux appareils numériques de la Class A prescrites dans le Règlement sur le brouillage radioélectrique édicté par le ministère des Communications du Canada.



Limited Warranty

American Power Conversion (APC) warrants its products to be free from defects in materials and workmanship for a period of two years from the date of purchase. Its obligation under this warranty is limited to repairing or replacing, at its own sole option, any such defective products. To obtain service under warranty you must obtain a Returned Material Authorization (RMA) number from APC or an APC service center. Products must be returned to APC or an APC service center with transportation charges prepaid and must be accompanied by a brief description of the problem encountered and proof of date and place of purchase. This warranty does not apply to equipment which has been damaged by accident, negligence, or mis-application or has been altered or modified in any way. This warranty applies only to the original purchaser who must have properly registered the product within 10 days of purchase.

EXCEPT AS PROVIDED HEREIN, AMERICAN POWER CONVERSION MAKES NO WARRANTIES, EXPRESS OR IMPLIED, INCLUDING WARRANTIES OF MERCHANTABILITY AND FITNESS FOR A PARTICULAR PURPOSE. Some states do not permit limitation or exclusion of implied warranties; therefore, the aforesaid limitation(s) or exclusion(s) may not apply to the purchaser.

EXCEPT AS PROVIDED ABOVE, IN NO EVENT WILL APC BE LIABLE FOR DIRECT, INDIRECT, SPECIAL, INCIDENTAL, OR CONSEQUENTIAL DAMAGES ARISING OUT OF THE USE OF THIS PRODUCT, EVEN IF ADVISED OF THE POSSIBILITY OF SUCH DAMAGE. Specifically, APC is not liable for any costs, such as lost profits or revenue, loss of equipment, loss of use of equipment, loss of software, loss of data, costs of substitutes, claims by third parties, or otherwise. This warranty gives you specific legal rights and you may also have other rights which vary from state to state.



Life Support Policy

As a general policy, American Power Conversion (APC) does not recommend the use of any of its products in life support applications where failure or malfunction of the APC product can be reasonably expected to cause failure of the life support device or to significantly affect its safety or effectiveness. APC does not recommend the use of any of its products in direct patient care. APC will not knowingly sell its products for use in such applications unless it receives in writing assurances satisfactory to APC that (a) the risks of injury or damage have been minimized, (b) the customer assumes all such risks, and (c) the liability of American Power Conversion is adequately protected under the circumstances.

Examples of devices considered to be life support devices are neonatal oxygen analyzers, nerve stimulators (whether used for anesthesia, pain relief, or other purposes), autotransfusion devices, blood pumps, defibrillators, arrhythmia detectors and alarms, pacemakers, hemodialysis systems, peritoneal dialysis systems, neonatal ventilator incubators, ventilators for both adults and infants, anesthesia ventilators, and infusion pumps as well as any other devices designated as “critical” by the U.S. FDA.

Hospital grade wiring devices and leakage current may be ordered as options on many APC UPS systems. APC does not claim that units with this modification are certified or listed as Hospital Grade by APC or any other organization. Therefore these units do not meet the requirements for use in direct patient care.

Table of Contents

1.0 Introduction	2
2.0 Safety! Sécurité! Sicherheit! ¡Seguridad!	4
3.0 Presentation	8
Isolation Unit (IU)	8
Electronics Unit (EU)	10
Battery Pack	12
4.0 Installation	14
Receiving inspection, Protection strategies, Moving the UPS, Placement	14
Input voltage requirements	16
Installation procedures	17
Input hard wiring procedure	18
Input voltage tap selection—208 Vac, 50/60 Hz use only	21
Output wiring procedure	22
Module interconnections	24
Emergency Power Off (EPO) interface	26
Start-up	27
5.0 Operation	28
Modes of operation	28
Display and controls operation	30
6.0 UPS Monitoring	38
Computer Interface port	39
7.0 Difficulty Difficulté Schwierigkeit Dificultad	40
Troubleshooting Chart	44
Fault messages	45
Replacing the Electronics Unit	46
Replacing or adding Battery Packs	47
Obtaining Service	48
8.0 Storing the UPS	49
9.0 Specifications	50
Recharge and Run Times	52

1.0 Introduction

1.1 Overview

The UPS is a high-power enhanced line-interactive uninterruptible power source which provides clean, reliable AC power to computer, data handling, and telecommunications loads. Normally, the UPS operates “on-line” and provides power derived from the input mains source, continuously regulating the load voltage to compensate for voltage fluctuations on the mains. A multilevel transformer tap changing circuit provides this regulation while attaining high levels of on-line efficiency. To adjust the load voltage, the UPS temporarily operates the load from battery power while an appropriate transformer tap change is made. If line conditions become unacceptable, the UPS transfers load power from the mains to the inverter (“on-battery” operation) synchronously and virtually seamlessly under all conditions. The voltage waveshape during on-battery operation is a low-distortion sine wave. Resynchronization and transfer of load power back to the mains is automatic when the line voltage is again within normal limits.

A complete UPS system consists of three module types: an Electronics Unit (EU) mounted on top of an Isolation Unit (IU), and Battery Packs, which can be added to increase on-battery run time. The EU self-connects to the IU when mounted, and contains the UPS’s microprocessor controls, inverter, battery charger, transfer and tap changing circuits, remote interfaces, and the user control and display panel. The IU contains the UPS’s isolation transformer, EMI/RFI filtering and surge-suppression circuits, bypass circuit, and the mains and load wiring interfaces. The Battery Packs “daisy chain” from the EU using a heavy duty cable and lockable connector system. The Battery Packs and the EU communicate over modular-plug cables. Each Battery Pack contains four high-capacity batteries and microprocessor-controlled electronics for communications and battery pack monitoring.

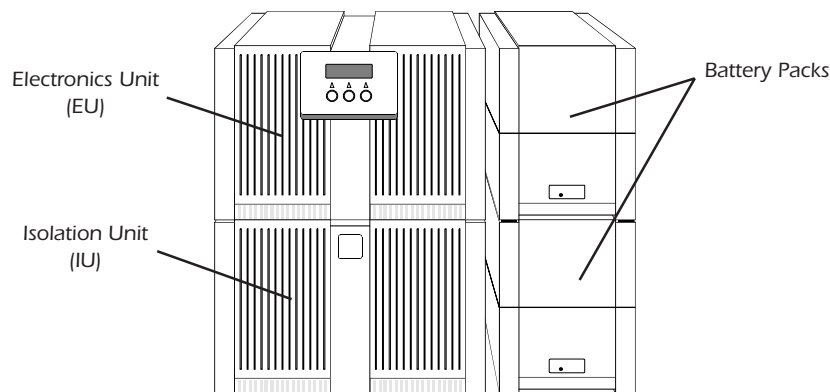

1.0 Introduction

1.2 Hot swappable modules

The IU is capable of autonomous operation and allows service or upgrade of the Electronics Unit without interruption of power to the load. In addition, a worn Battery Pack can be replaced, or new packs can be added, while maintaining power to the load. In the event of EU failure, functions controlled by the EU are automatically bypassed and the IU operates autonomously. For servicing, this bypass mode may be selected manually.

1.3 Emergency Power Off (EPO)

For applications where, for safety reasons, power to all room equipment may be cut off, the UPS provides a remote Emergency Power Off interface.

1.4 Display

Local UPS user interface is served by a display and control panel containing a back-lit 2×16 character display and three buttons. Using the buttons, menus for displaying UPS status, UPS control commands, UPS setup, UPS tests and UPS diagnostics are shown. Critical UPS functions can be password protected. A loud audible alarm warns of operating modes that could result in the loss of power to the load without user intervention.

1.5 Remote interfaces

The UPS provides a full RS-232 communications computer interface. When used with PowerDoctor UPS monitoring software and a serially connected local DOS PC, the local display and control panel functions are duplicated and power quality events can be logged. PowerChute *plus* offers the features of PowerDoctor, and the control of orderly and unattended network or multi-user computer system shutdown. Also available for the UPS is the SNMP (Simple Network Management Protocol) Adapter to provide load-type independent remote monitoring and management over Ethernet or Token Ring based LANs or WANs capable of routing IP messages. Using any standard Network Management System (NMS) and the SNMP Adapter, the UPS is manageable through a single familiar interface—from across your building or across the world.



CAUTION!

- To reduce the risk of electric shock, disconnect the Uninterruptible Power Source from the mains before installing computer interface signal cable (when used). Reconnect the power cord only after all signalling interconnections have been made.
- Connect the Uninterruptible Power Source to a two-pole, three-wire grounding mains receptacle. The receptacle must be connected to appropriate branch protection (fuse or circuit breaker). Connection to any other type of receptacle may result in a shock hazard and may violate local electrical codes.
- This Uninterruptible Power Source has an internal energy source (the battery) that cannot be de-energized by the user. **The output may be energized when the unit is not connected to a mains supply.**
- To properly deenergize the Uninterruptible Power Source in an emergency, move the rear panel I/O switch to the O (off) position and disconnect the power cord from the mains.
- Avoid installing the Uninterruptible Power Source in locations where there is water or excessive humidity.
- Do not allow water or any foreign object to get inside the Uninterruptible Power Source. Do not put objects containing liquid on or near the unit.
- To reduce the risk of overheating the Uninterruptible Power Source, avoid exposing the unit to the direct rays of the sun. Avoid installing the unit near heat emitting appliances such as a room heater or stove.



ATTENTION!

- Pour réduire le risque d'électrocution, débranchez la prise principale de la source d'alimentation permanente (Uninterruptible Power Source), avant d'installer le câble d'interface allant à l'ordinateur (si utilisé). Ne rebranchez le bloc d'alimentation qu'après avoir effectué toutes les connections.
- Branchez la source d'alimentation permanente (UPS) dans une prise de courant à 3 dérivations (deux pôles et la terre). Cette prise doit être munie d'une protection adéquate (fusible ou coupe-circuit). Le branchement dans tout autre genre de prise pourrait entraîner un risque d'électrocution et peut constituer une infraction à la réglementation locale concernant les installations électriques.
- Cette source d'alimentation permanente (UPS) est munie d'une source d'énergie interne (accumulateur) qui ne peut pas être désactivée par l'utilisateur. **La prise de sortie peut donc être sous tension même lorsque l'appareil n'est pas branché.**
- En cas d'urgence, pour désactiver correctement la source d'alimentation permanente (UPS), poussez l'interrupteur du panneau arrière sur la position O (Off) et débranchez le cordon d'alimentation principal.
- Ne pas installer la source d'alimentation permanente (UPS) dans un endroit où il y a de l'eau ou une humidité excessive.
- Ne pas laisser de l'eau ou tout objet pénétrer dans la source d'alimentation permanente (UPS). Ne pas placer de récipients contenant un liquide sur cet appareil, ni à proximité de celui-ci.
- Pour éviter une surchauffe de la source d'alimentation permanente (UPS), conservez-la à l'abri du soleil. Ne pas installer à proximité d'appareils dégageant de la chaleur tels que radiateurs ou appareils de chauffage.



VORSICHT!

- Um die Gefahr eines elektrischen Schlages auf ein Minimum zu reduzieren, die unterbrechungsfreie Stromversorgung vom Stromnetz trennen, bevor ggf. ein Computer-Schnittstellensignalkabel angeschlossen wird. Das Netzkabel erst nach Herstellung aller Signalverbindungen wieder einstecken.
- Die unterbrechungsfreie Stromversorgung an eine geerdete zweipolige Dreiphasen-Netzsteckdose anschließen. Die Steckdose muß mit einem geeigneten Abzweigschutz (Sicherung oder Leistungsschalter) verbunden sein. Der Anschluß der unterbrechungsfreien Stromversorgung an einen anderen Steckdosentyp kann zu Stromschlägen führen und gegen die örtlichen Vorschriften verstoßen.
- Diese unterbrechungsfreie Stromversorgung besitzt eine interne Energiequelle (Batterie), die vom Benutzer nicht abgeschaltet werden kann. **Der Ausgang kann eingeschaltet werden, wenn das Gerät nicht an das Stromnetz angeschlossen ist.**
- Um die unterbrechungsfreie Stromversorgung im Notfall ordnungsgemäß abzuschalten, den I/O-Schalter an der Rückseite auf O (Aus) stellen und das Netzkabel aus der Steckdose ziehen.
- Die unterbrechungsfreie Stromversorgung nicht an einem Ort aufstellen, an dem sie mit Wasser oder übermäßig hoher Luftfeuchtigkeit in Berührung kommen könnte.
- Darauf achten, daß weder Wasser noch Fremdkörper in das Innere der unterbrechungsfreien Stromversorgung eindringen. Keine Objekte, die Flüssigkeit enthalten, auf oder neben die unterbrechungsfreie Stromversorgung stellen.
- Um ein Überhitzen der unterbrechungsfreien Stromversorgung zu verhindern, das Gerät vor direkter Sonneneinstrahlung fernhalten und nicht in der Nähe von wärmeabstrahlenden Haushaltsgeräten (z.B. Heizgerät oder Herd) aufstellen.



¡ATENCIÓN!

- Para reducir el riesgo de descarga eléctrica, desconecte de la red la Fuente de energía ininterrumpible antes de instalar el cable de señalización de interfaz de la computadora (si se usa). Vuelva a conectar el conductor flexible de alimentación solamente una vez efectuadas todas las interconexiones de señalización.
- Conecte la Fuente de energía ininterrumpible a un tomacorriente bipolar y trifilar con neutro de puesta a tierra. El tomacorriente debe estar conectado a la protección de derivación apropiada (ya sea un fusible o un disyuntor). La conexión a cualquier otro tipo de tomacorriente puede constituir peligro de descarga eléctrica y violar los códigos eléctricos locales.
- Esta Fuente de energía ininterrumpible tiene una fuente de energía interna (la batería) que no puede ser desactivada por el usuario. **La salida puede tener corriente aun cuando la unidad no se encuentre conectada al suministro de red.**
- Para desactivar correctamente la Fuente de energía ininterrumpible en una situación de emergencia, coloque el interruptor I/O del panel posterior en la posición O (Off–desconectado) y desconecte de la red el conductor flexible de alimentación.
- No instale la Fuente de energía ininterrumpible en lugares donde haya agua o humedad excesiva.
- No deje que en la Fuente de energía ininterrumpible entre agua ni ningún objeto extraño. No ponga objetos con líquidos encima de la unidad ni cerca de ella.
- Para reducir el riesgo de sobrecalentamiento, no exponga la unidad a los rayos directos del sol ni la instale cerca de artefactos que emiten calor, como estufas o cocinas.

3.0 Presentation

3.1 Isolation Unit (IU)

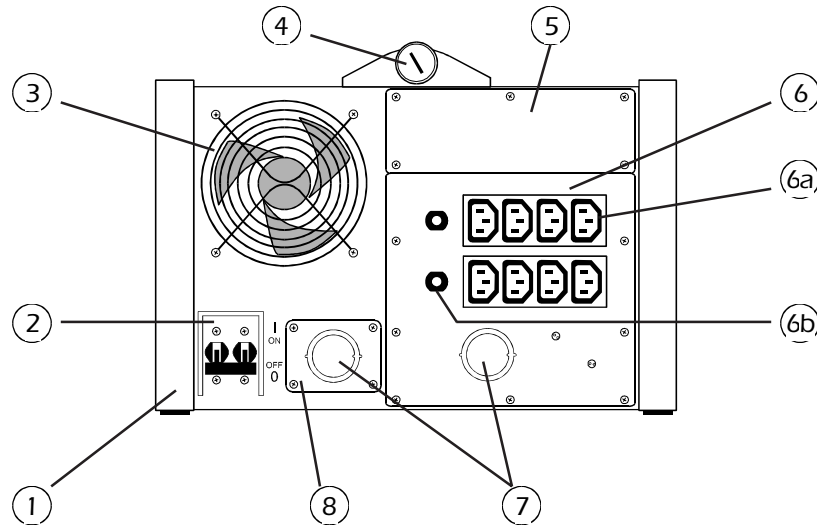

Rear view of the Isolation Unit

① Isolation Unit (IU)

The Isolation Unit contains the UPS's isolation transformer, EMI/RFI and surge suppression, bypass circuits including an auxiliary power supply, and mains and load wiring interfaces. The IU is capable of autonomous operation and allows service of the Electronics Unit without interruption of power to the load.

② Input circuit breaker (power ON / OFF)

The input circuit breaker controls power to the UPS. It protects the UPS and the service wiring from extreme overloads.

③ Cooling fan

The fan exhausts air from the IU and operates whenever the input circuit breaker is ON (I). If the fan fails, the UPS will indicate an alarm condition. Under such conditions, the UPS will remain operating and is capable of delivering full power to the load.

3.0 Presentation

④ EU separating screw

The Electronics Unit separating screw is turned counterclockwise to remove the EU for service. If this action is taken while the UPS is on-line, the UPS will automatically transfer to bypass operation. See the **Difficulty** section of this manual for the proper EU replacement procedure.

Note: The UPS's display is blank when the EU separating screw is loosened. Control of the UPS is regained when the screw is tightened and any control button is pressed.

⑤ Wiring inspection cover

When removed, the wiring inspection cover reveals the output wiring connections to the UPS. It is necessary to inspect the connections during installation as the wires may move when the power distribution plate is reattached. See the **Installation** section of this manual.

⑥ Power distribution plate

The standard furnished power distribution plate is removable for access to the input and output wiring terminations, and to the input voltage selection taps. Optional power distribution plates with wiring devices other than those provided as standard can be ordered from the factory and installed in the field.

⑥a) IEC 320 C13 receptacles

A total of eight IEC 320 C13 outlets are provided for multiple small loads.

⑥b) IEC 320 C13 receptacle circuit breaker

Each row of quad IEC 320 C13 output receptacles is protected by a 12 Amp circuit breaker. This protection is necessary because the UPS is capable of delivering more than the receptacle's maximum current rating.

⑦ Electrical fittings knockouts

Knockouts appropriate for use with 0.75-in. (19 mm) and 1-in. (25 mm) electrical cable clamp fittings are provided at the input cable plate, and at the output power distribution plate.

⑧ Input cable plate

The input cable plate is removed during the input wiring installation.

3.0 Presentation

3.2 Electronics Unit (EU)

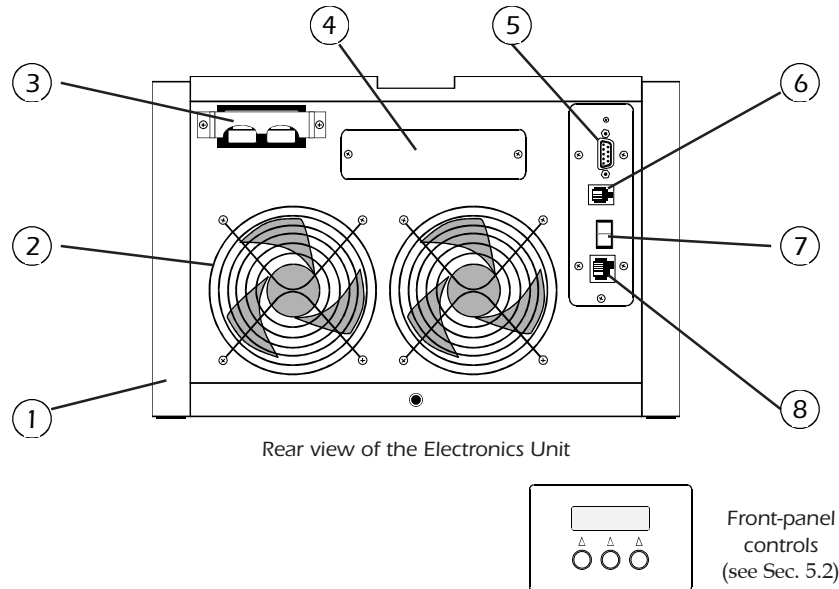

① Electronics Unit (EU)

The Electronics Unit contains the UPS's microprocessor controls, inverter, battery charger, transfer and tap changing circuits, remote interfaces, and the user control and display console. The EU may be separated from the IU for service. See the manual section entitled **Difficulty** for instructions on removal of the EU.

② Cooling fans

The EU cooling fans operate at two speeds depending upon mode of operation. The fans turn faster when the UPS is heavily loaded while operating on-battery. If either of the fans fail while operating on-line, the UPS will indicate an alarm condition and transfer to bypass operation. If either of the fans fail while operating on-battery, the UPS will immediately indicate an alarm condition. Initially, the UPS will continue to provide power to the load. However, when heavily loaded the UPS will eventually shut down in order to prevent the EU from overheating.

3.0 Presentation

③ Battery Pack coupler

Battery Packs are connected at this coupler. A coupler clamp is installed over the coupler opening as furnished from the factory. See the Installation section for instructions on how to lock mated couplers.

④ Accessory panel

The EU is furnished with an opening that accepts accessories that work with the UPS. Call your dealer or the factory for information on available accessories.

⑤ Computer interface port

See the UPS Monitoring section of this manual for information on this interface port.

⑥ Battery communications jack

The Battery Pack communications cable from the Battery Pack OUTPUT is connected at this jack.

⑦ Manual bypass switch

Pressing the manual bypass switch causes the UPS to transfer to the bypass mode of operation. While in this mode, the load is supplied with power conditioned by the IU. However, the load will not be protected from mains voltage sags, swells or blackouts. The EU is removed for service when the UPS is operating in bypass. See the Operation section of this manual for more details on this mode of operation.

⑧ Emergency Power Off jack

For applications where, for safety reasons, power to all room equipment must be cut off, the UPS provides a remote Emergency Power Off interface. A modular 6 position plug with offset latch fits this jack. See the Installation section of this manual for instructions on how to connect to the jack.

3.0 Presentation

3.3 Battery Pack

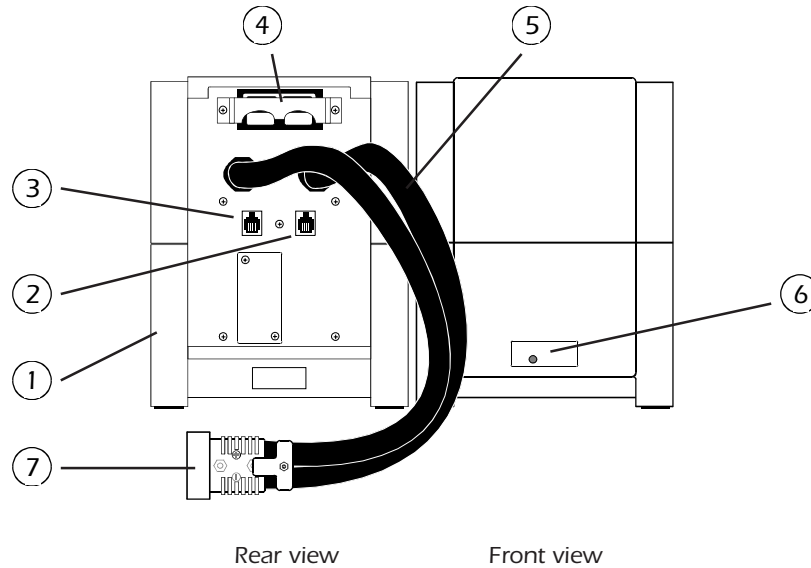

① Battery Pack

The Battery Pack contains four series connected nominal 12 Vdc high capacity sealed lead-acid batteries. Built-in ultra-low power consumption battery pack voltage and current monitoring electronics report pack status to the UPS. To conserve battery capacity, the internal electronics are shut down when the battery communications cable is not connected to the UPS, or when the UPS is not running.

② INPUT battery communications jack

This input accepts battery status signals from the OUTPUT of another Battery Pack in the system. No connection is made to this jack in a single Battery Pack system.

③ OUTPUT battery communications jack

The Battery Pack sends status signals to the UPS or to the INPUT of another Battery Pack (in a multiple Battery Pack system) from this jack.

3.0 Presentation

④ Battery Pack panel coupler

Additional Battery Packs are connected to this panel coupler. A coupler clamp is installed over the coupler opening as furnished from the factory. See the Installation section of this manual for instructions on how to lock mated couplers.

⑤ Battery Pack cables

Each Battery Pack cable is made from “welding grade” wire to withstand abrasion or crimping in rough duty applications.

⑥ Replace Battery indicator

The Replace Battery indicator is illuminated when the Battery Pack can no longer sustain a charge due to wear. See the Difficulty section of this manual if the indicator is lit.

⑦ In-line Battery Pack coupler

The in-line Battery Pack coupler connects to the UPS or to the panel coupler on another Battery Pack.

⑧ Battery communications cable

Each Battery Pack is supplied with a battery communications cable.

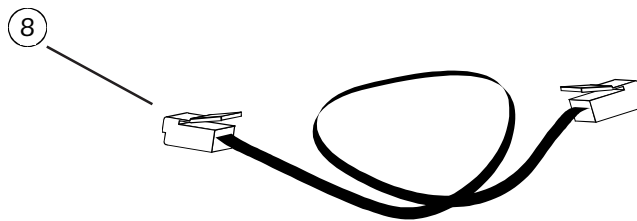

4.0 Installation

4.1 Receiving inspection

Once the UPS has been removed from its shipping container, it should be inspected for damage that may have occurred while in transit. Immediately notify the carrier and place of purchase if any damage is found. The packing materials are made from recyclable materials and should be saved for reuse or disposed of properly.

4.2 Protection Strategies

This UPS provides high performance power line protection to the loads. There are, however, other potential entry points for damaging surges in information systems. These include serial ports (RS-232, RS-422, RS-485, etc.), parallel ports, telephone lines, and network connections. These other entry points must be considered in developing a comprehensive system protection strategy. Contact your dealer or call the number on the back cover of this manual for information on a complete set of related products designed to accomplish total system protection.

Sensitive information systems can be further safeguarded by following these guidelines:

- Verify that all electrical outlets are properly grounded.
- Connect information systems to a different electrical service branch than heavy motor loads like air conditioners, copiers, refrigerators, and heavy industrial machinery.
- Plug all power protection and information system equipment into the same branch where possible.

4.3 Moving the UPS

The UPS is heavy and should be moved to the operating site by hand truck. Two people are necessary to load the UPS into position on the truck noseplate. Load the UPS onto the hand truck as shown below. Use hand truck straps to stabilize the load while moving.

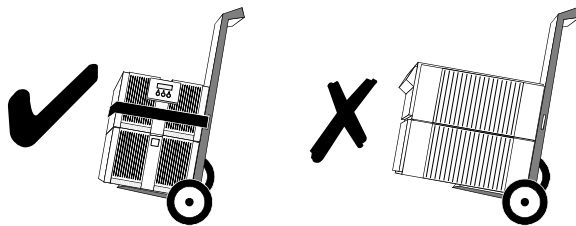

Caution:
Never attempt to lift the UPS by the Electronics Unit or by the EU separating screw!

4.0 Installation

4.4 Placement

The UPS may be installed in any protected environment. The location should provide adequate air flow around the unit, in an atmosphere free from excessive dust. Do not operate the UPS in an environment where the ambient temperature or humidity is outside the limits given in the Specifications section of this manual.

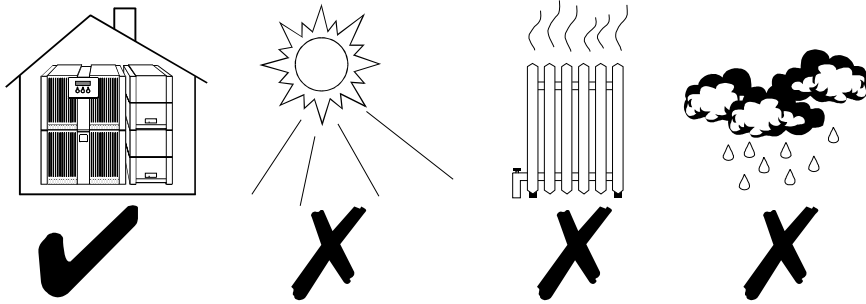

4.0 Installation



■ **Warning:** Risk of electric shock exists inside the UPS. Input voltage tap selection and power distribution panel replacement should be performed only by qualified service personnel.

■ **Avertissement:** Un risque de choc électrique existe à l'intérieur de l'UPS. La sélection des fils de tension d'entrée et le remplacement du panneau de distribution de puissance doivent être effectués seulement par du personnel d'entretien et réparations qualifié.

■ **Warnung:** Im Inneren der unterbrechungsfreien Spannungsversorgung besteht die Gefahr des elektrischen Schlages. Spannungswahl und Austausch der Verteilereinheit darf nur von qualifiziertem Servicepersonal durchgeführt werden.

■ **Advertencia:** Dentro de la Fuente de Poder Ininterrumpible existe el riesgo de una descarga eléctrica. Tanto la selección de las conexiones para el voltaje de entrada como el reemplazo del panel de distribución de potencia deben ser realizados por personal de servicio calificado.

4.5 Input voltage requirements

4.5.1 208 Vac operation

The UPS may be installed where the nominal single phase voltage is 208 Vac, 50/60 Hz. However, an alternate power distribution plate must be installed as the supplied receptacles are not appropriate for use with such service. In addition, an input voltage tap selection must be made for proper operation. Call your dealer or Customer Service for information on available power distribution plates (also called "PDUs") for this UPS.

4.5.2 220–240 Vac operation

The UPS may be installed where the nominal single phase voltage is 220, 230, or 240 Vac; 50 or 60 Hz. As supplied, the UPS will deliver a nominal 240 Vac at the output receptacles with the output frequency and phase automatically synchronized to the mains. Using the control and display panel, the nominal output voltage may be set to 220, 225, 230, or 240 Vac.

The UPS may be installed in TN-S, TN-C-S, TN-C, and TT Power Systems. These Power Systems have a protective function (wire) that is directly earthed.

4.0 Installation

4.6 Installation procedures

Note: Except as described below for installing the 3000 VA model with the supplied mains lead, UPS input power connections must be made by qualified service personnel.

The UPS may be connected to input power with either the included materials or through a hard wired approach (see section 4.7 below).

The 3000 VA model is equipped with an IEC 320 C20 type input power receptacle, a mains lead with a CEE7/7 type plug, and a knock out plate for hard wired installation. The 5000 VA model is supplied with an attached 3-conductor mains lead. Hard wired installation of the 5000 VA model requires removal of the attached mains lead/strain relief assembly from the input power plate.

■ **Important!**

The cores in the supplied 5000 VA model mains lead are colored in accordance with the following code:

green and yellow	earth
blue	neutral
brown	live

As the colors of the cores in the attached mains lead may not correspond to the colored markings that identify your plug terminals, proceed as follows:

The core which is colored green and yellow must be connected to the terminal in plug marked E or by the earth symbol , or colored green and yellow.

The core which is colored blue must be connected to the terminal which is marked with the letter N or colored black.

The core which is colored brown must be connected to the terminal which is marked with the letter L or colored red.

4.6.1 Required materials

■ **Input and output electrical cable**

Follow the cable sizing recommendations below for a hard wired installation. Plan on leaving at least 1.0 m (3.3 ft) of slack mains lead so that the UPS can be moved for maintenance or for the addition of new loads. Output cable is needed only when any individual load requires more than 10 Amps.

4.0 Installation

Cable Size			Strip Length	
Model	Minimum	Maximum	Input Cable	Output Cable
3000 VA	4 mm ² 12 AWG	10.0 mm ² 8 AWG	12 mm 1/2"	9 mm 3/8"
5000 VA	6.0 mm ² 10 AWG	10.0 mm ² 8 AWG		

■ Cable clamps

The UPS is not furnished with cable clamps for strain relief. Use only approved 0.75-in. (19-mm) or 1.0-in. (25-mm) fittings.

4.6.2 Required tools

- Electrician's pliers
- Hammer
- Nail set or punch
- Flat blade screwdriver
- No. 2 Phillips screwdriver

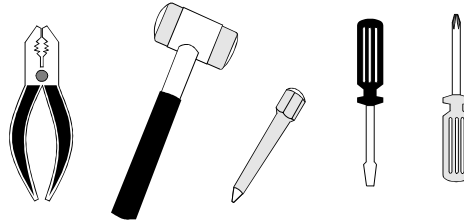

4.7 Input hard wiring procedure

4.7.1 Switch off (O) the UPS's input circuit breaker.

4.7.2 Determine the size of the electrical cable clamp fittings to be used, either 0.75 in. (19 mm) or 1.0 in. (25 mm), and remove the appropriate knockout on the supplied input cable plate (3000 VA model) or remove the attached mains lead and strain relief at the rear of the Isolation Unit (5000 VA unit).

To remove a knockout, strike in the area shown with a nail set tool and hammer. Grasp the edge of the knockout with pliers and twist until the knockout is separated from the plate.

Caution: *The edge of the knockout may be sharp!*

4.0 Installation

4.7 Input hard wiring procedure (continued)

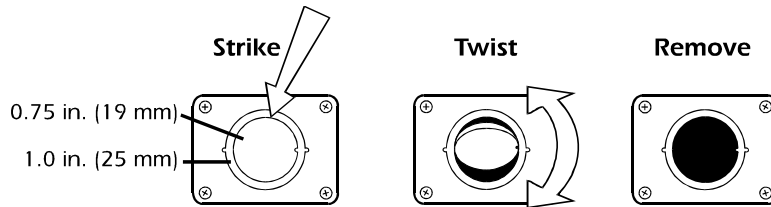

Example showing removal of 0.75-in. (19-mm) knockout

4.7.3 Remove the input cable plate from the Isolation Unit.

4.7.4 Fasten an appropriately sized and approved cable clamp (not provided) onto the input cable plate.

4.7.5 If you plan to hardwire output loads to the UPS, remove the knockout on the power distribution plate now.

4.7.6 Remove all screws that secure the wiring inspection cover and power distribution plate from the rear of the Isolation Unit. Move the power distribution plate aside gently. Take care not to strain the wires connected to the devices on the plate.

4.7.7 Strip insulation from the mains lead wire ends at the length given in the Cable Size table.

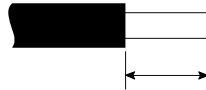

See Electrical Cable Size Table

4.0 Installation

4.7 Input hard wiring procedure (continued)

4.7.8 Thread the mains lead through the cable clamp and through the input cable plate hole in the Isolation Unit. Arrange the cable so that the end is near the input terminations block.

4.7.9 Put the stripped wire end corresponding to mains Line 1 into the terminations block terminal marked L1 and tighten the screw.

4.7.10 Put the stripped wire end corresponding to mains Protective Earth into the terminations block terminal marked with a yellow stripe and \oplus and tighten the screw.

4.7.11 Insert the stripped wire end for the mains Neutral (or Line 2) into the terminations block terminal marked L2/N and tighten the screw.

4.7.12 Check that there are no loose wire strands and that the terminations block screws are sufficiently tightened.

4.7.13 Reattach the input cable plate and tighten the cable clamp.

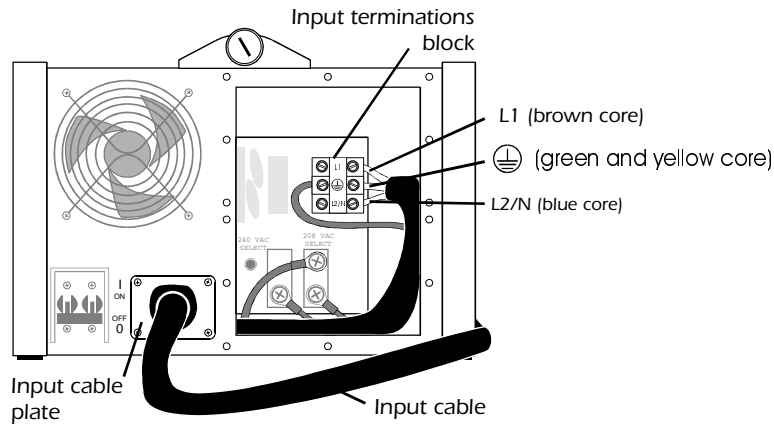

Typical input cable installation

4.0 Installation

4.8 Input voltage tap selection—208 Vac, 50/60 Hz use only

As furnished, the UPS is configured to operate from a single phase 220–240 Vac, 50/60 Hz source. To operate the UPS from a 208 Vac, 50/60 Hz source, the UPS must be reconfigured. The steps required for this action are listed below. Note that regardless of the input voltage tap selected, the UPS's output will remain in the 220–240 Vac range unless an alternate power distribution plate is installed.

4.8.1 Turn off (O) the UPS's input circuit breaker and unplug the input power cord.

4.8.2 Remove the 10-32 x 3/8-in. SEM screw holding the red Input Voltage Select Wire (see illustration) to the tap bar marked “240 VAC SELECT.”

4.8.3 Move the red Input Voltage Select Wire to the tap bar marked “208 VAC SELECT” and tighten the screw.

4.8.4 See Section 5.2.6 to check the UPS's upper transfer to on-battery voltage and to set the UPS's output voltage reporting to “208 V.”

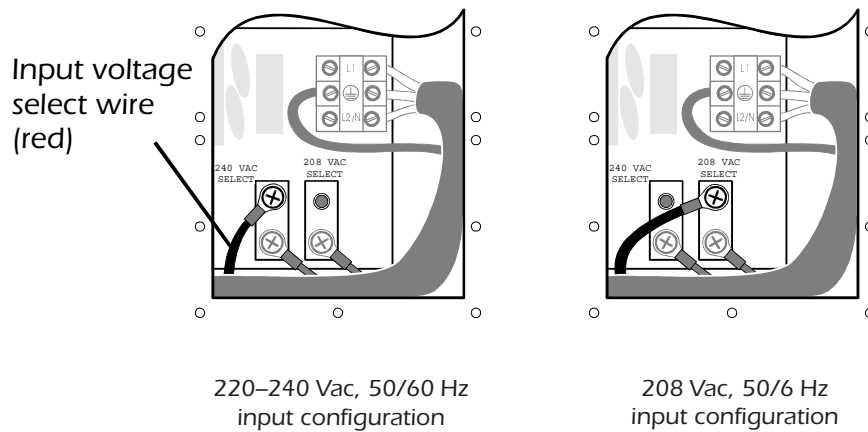

4.0 Installation

4.9 Output wiring procedure

As furnished, the UPS provides a total of eight IEC 320 C13 business appliance receptacles for multiple small loads. To connect to these outlets, use the supplied output jumper cords. These jumper cords replace the line cords supplied with your computer equipment.

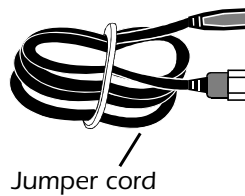

Loads requiring more than 10 Amps must be hard wired to the UPS. To install output wiring to the UPS, follow the below listed procedure.

4.9.1 If the desired power distribution plate knockout has not already been removed, remove it now. See Section 4.7.2 for instructions on how to remove the knockout.

4.9.2 Fasten an appropriately sized and approved cable clamp (not provided) onto the power distribution plate.

4.9.3 Strip insulation from the output cable wire ends at the length given in The Electrical Cable Size table.

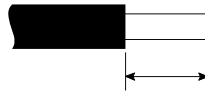

See Electrical Cable Size Table

4.9.4 Thread the output cable through the cable clamp and through the power distribution plate hole. Arrange the cable so that the end is near the output terminations block.

4.9.5 Put the stripped wire end corresponding to Protective Earth into the terminations block terminal marked PE and tighten the screw.

4.0 Installation

4.9 Output wiring procedure (continued)

4.9.6 Put the stripped wire end corresponding to Neutral into the terminations block terminal marked N and tighten the screw.

4.9.7 Put the stripped wire end corresponding to Line into the terminations block terminal marked L and tighten the screw.

4.9.8 Check that there are no loose wire strands and that the terminations block screws are sufficiently tightened.

4.9.9 Reattach the power distribution plate to the Isolation Unit.

4.9.10 Check that the output wiring terminations are not strained and reattach the wiring inspection cover.

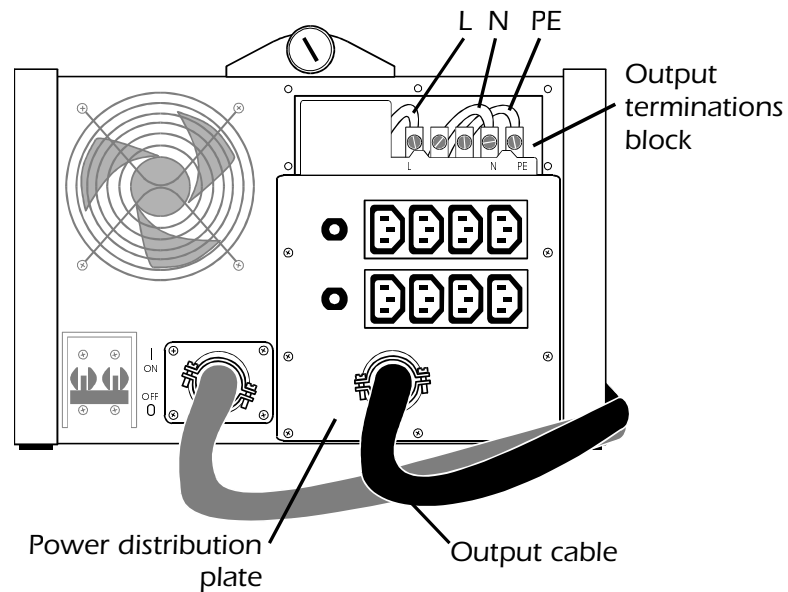

4.0 Installation

4.10 Module interconnections

Follow the instructions listed below to install and lock the battery couplers.

4.10.1 Using a phillips screwdriver, remove the battery coupler clamps from the Electronics Unit and from all but one Battery Pack.

4.10.2 Turn the battery coupler clamp over and fasten loosely to one side.

4.10.3 Connect the battery couplers as shown in the figure below.

4.10.4 Fasten the other side of the battery coupler clamp to secure couplers.

Note: To reduce the risk of toppling, do not stack equipment more than 2 units high.

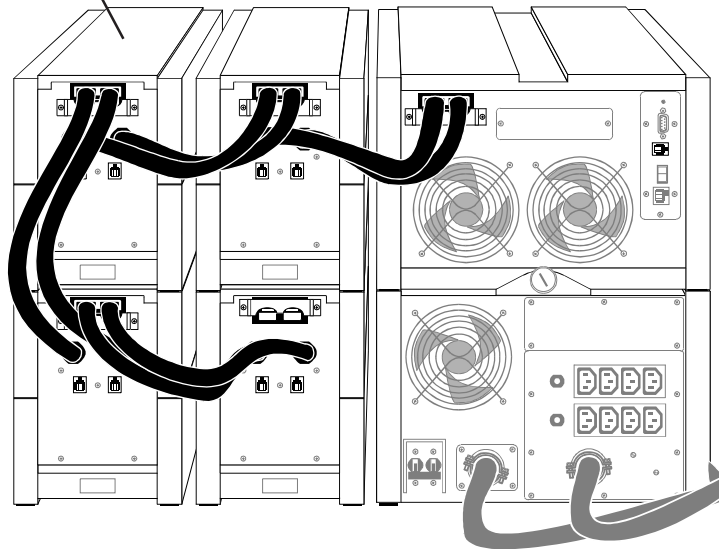
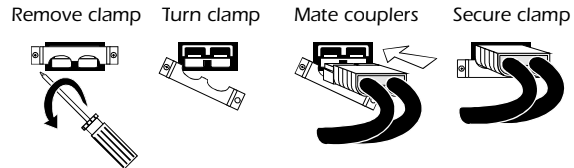

Typical installation showing mated battery couplers.

4.0 Installation

4.10 Module interconnections (continued)

Follow the instructions below to install the battery communications cables.

4.10.5 Mate the battery cable plugs in the fashion illustrated below.

4.10.6 Each cable must connect between a Battery Pack OUTPUT and either the UPS's BATT COMM input, or another Battery Pack INPUT.

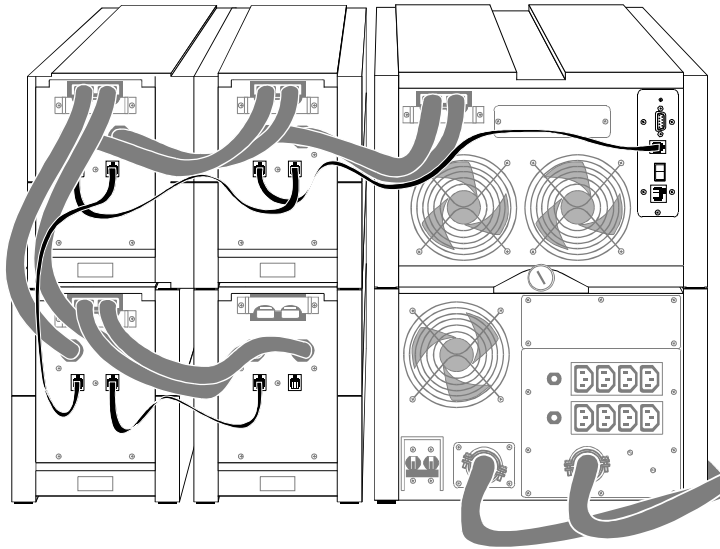
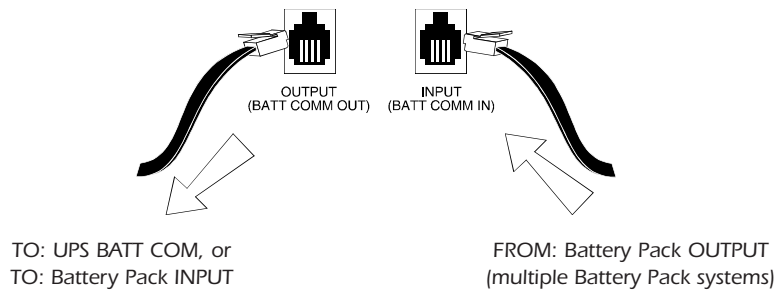

Typical installation showing mated battery communications cables.

4.0 Installation

4.11 Emergency Power Off (EPO) interface

The UPS may be switched off by a remotely operated Emergency Power Off control. Such a configuration is common in computer rooms and laboratories where, for safety reasons, power to the loads must be disconnected. The EPO interface is a six-position modular jack with an offset latch. Connection to a remotely located EPO switch may be accomplished as shown below.

Caution: The EPO interface is a Safety Extra Low Voltage (SELV) circuit and may be connected only to other SELV circuits.

Attention: L'interface de mise hors tension d'urgence est un circuit de sécurité à très basse tension qui ne peut être connecté qu'à d'autres circuits de sécurité à très basse tension.

Beachte: Die Schnittstelle für die Notabschaltung ist eine Schutzkleinspannungsschaltung (SELV = safety extra low voltage circuit) und darf nur an andere Kleinspannungsschaltungen angeschlossen werden.

Precaución: La interfaz de Parada de Emergencia es un circuito de seguridad de extra bajo voltaje, y puede conectarse únicamente a otros circuitos de seguridad de extra bajo voltaje.

Caution: The EPO interface is designed to monitor circuits that have no determined voltage potential. Such "closure circuits" may be provided by a switch or relay properly isolated from the mains. Connection of the EPO interface to any circuit other than a closure type circuit may cause damage to the Electronics Unit.

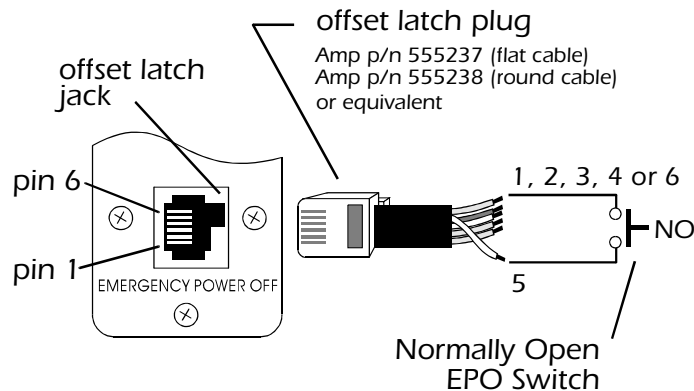

4.0 Installation

4.12 Start-up

To start the UPS, follow the instructions listed below.

4.12.1 If a UPS monitoring signal cable is to be installed, connect it to the Electronic Unit's Computer Interface Port. For more details on the Computer Interface port, see the UPS Monitoring section.

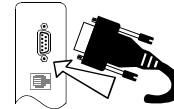

4.12.2 Plug all loads to be protected into the UPS. Do not exceed the UPS's maximum capacity as listed in the Specifications section of this manual. The total load capacity is continuously monitored by the UPS and is displayed once the UPS is switched on.

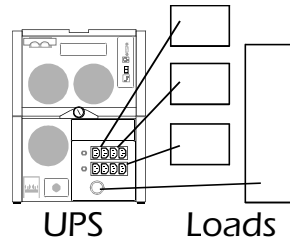

4.12.3 Connect power to the UPS by switching on the service branch protection circuit breaker.

4.12.4 Power the UPS by switching On the input circuit breaker.

Note: The UPS may make a “bump” noise when first switched on. This is normal. The UPS will not make this sound again.

Note: If the input circuit breaker is rapidly switched On-Off-On, the UPS may operate in the bypass mode. Follow the display prompts to return to normal on-line operation.

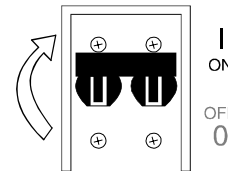

4.12.5 The UPS should display its status as “OnLine.” When first turned on, the UPS may adjust the on-line output voltage. Soft “clicking” sounds may be heard when this is accomplished. This is normal.

Note: See the Difficulty section of this manual if the UPS displays a fault message.

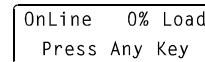

4.12.8 Switch on the protected loads and check the UPS's display. Total load capacity is displayed as a percentage of the UPS's full rated capacity. It should read below 100%. If above 100%, the UPS will indicate an overload.

4.12.9 If desired, set the UPS's output voltage—see Section 5.2.6.

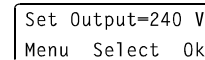

5.0 Operation

5.1 Modes of operation

The UPS operates in one of five modes—sleep, standby, on-line, on-battery, and bypass—depending upon the condition of the UPS, the batteries, the loads, and the input mains voltage.

5.1.1 Sleep mode

In sleep mode, the UPS's display is inactive and no voltage is present at the output. The UPS is put to sleep manually when commanded "Off" by the user. The UPS automatically enters sleep mode after 5 minutes with no commands given while in standby mode (see following section). After 5 minutes, the UPS enters sleep mode from on-battery mode when shut down because of battery exhaustion or overload, to conserve battery capacity. Press any front-panel button to "awaken" the UPS.

Some versions of PowerChute *plus* allow remote users to put the UPS to sleep and awaken it after a set interval.

5.1.2 Standby mode

While in standby mode, the UPS's display and control interface is active, but no voltage is present at the output. The UPS enters standby mode when first "awakened" from sleep mode.

5.1.3 On-line mode

Once commanded to power the loads, the UPS is normally in on-line mode. While in this mode the UPS delivers power derived from the mains to the loads, maintains proper battery charge, regulates the output voltage to within a narrow band, and isolates the load from surges and electrical noise brought by the service wiring. A multilevel transformer tap changing circuit provides this regulation and isolation while maintaining extremely high efficiency. When adjusting the load voltage, the UPS temporarily operates the load from battery power while it makes an appropriate transformer tap change. Remote on-battery signaling is disabled during a tap change. The UPS's display indicates the percent of rated load applied at the output when operating on-line.

5.1.4 On-battery mode

When in on-battery mode, the UPS supplies load power derived by the UPS's inverter from the Battery Packs. The voltage waveshape delivered in on-battery mode is a low-distortion sine wave. While on-battery, the UPS regulates the output voltage and frequency to within a narrow band. The UPS operates in on-battery mode during the user-defeatable start-up or scheduled battery tests. The UPS operates on-battery when the line voltage or frequency has fallen outside the limits given in the **Specifications** section or has become extremely distorted by, for example, noisy adjacent service branch loads or an overburdened fuel generator source.

5.0 Operation

Operation on-battery is limited in duration according to available battery capacity and load. Local users are alerted to this mode by visual and audible indicators. When on-battery, the UPS displays available run time and emits a sequence of four beeps every 30 seconds. During an extended mains failure, the battery capacity will eventually become too low to support the load and the UPS will shut down. The UPS alerts the user to a low battery condition 2, 5, 7, or 10 minutes before shutdown, depending upon the user setting. The UPS beeps once every second to warn local users of the low battery condition. The UPS alerts remote users to on-battery operation and low battery conditions using serial communications or simple signaling from the Computer Interface port.

5.1.5 Bypass mode

When in bypass mode, the load is supplied power conditioned by the Isolation Unit. However, the load is not protected from mains voltage sags, swells, or blackouts. The UPS automatically transfers to bypass mode when a failure occurs in the Electronics Unit, including blocked fan, battery charger fault, overtemperature, and welded main relay—see Section 7.2 for a complete list of fault messages. The UPS also automatically transfers to bypass if the EU separating screw is loosened. A manual bypass switch on the EU is used when maintenance of the EU is required. The UPS must be returned to on-line operation manually.

Local users are alerted to this mode by visual and audible indicators. When in bypass, the UPS displays the reason for bypass (fan failure, EU switch actuated, etc.) and beeps. The UPS alerts remote users to the bypass conditions via serial communications from the Computer Interface port.

5.1.6 Transfer between modes of operation

Transfer of load power to and from all modes of operation occurs synchronously with the mains voltage phase. See the Specifications section of this manual for transfer time ratings.

5.0 Operation

5.2 Display and controls operation

The UPS is equipped with a 2x16 character back lit liquid crystal display (LCD) and three button keypad user interface. The display is structured with five main menu screens and a default screen. Each main menu screen allows access to several sub-menu screens. Using the pushbuttons, the user can scroll through the menus and access information or control choices for UPS operation, status, diagnostics, set-up and tests. The main menu and sub-menu selections are described in the following sections.

5.2.1 Default screens

```
OnLine xxx% Load
Press Any Key
```

```
OnBattery
xxx Mins Remain
```

```
In Bypass Mode
Press Any Key
```

The UPS's mode is displayed on the default screen. Important fault messages are also shown on the default screen. The UPS shows the default screen and the main menu screens when the Menu key is successively pressed. The UPS automatically shows the default screen if there is no keypad activity for 3 minutes, or if warranted by a mode change or device failure.

Examples of the most common default screens are shown at left.

5.2.2 Main menu screens

```
UPS Control
Menu      Scroll
```

```
UPS Status
Menu      Scroll
```

```
UPS Diagnostics
Menu      Scroll
```

```
UPS Setup
Menu      Scroll
```

```
UPS Tests
Menu      Scroll
```

The UPS shows the main menu screens when any default screen key is pressed or when the Menu key is successively pressed. The five main menu screens are shown in order at left.

The main menu screens allow access to screens that display operational choices or show information on UPS status, diagnostics, set-up, and tests. Access to the sub-menu screens is gained by pressing the Scroll key. To return to the main menu, press the Menu key.

5.0 Operation

5.2.3 UPS Control menu

The UPS Control menu allows the user to access sub-menus that show UPS switch on/off and bypass in/out operation choices. To avoid accidentally powering or unpowering the load when a UPS on/off control choice is mistakenly entered, the UPS will ask the user to confirm the choice.

5.2.4 UPS Status menu

The UPS Status menu allows the user to access sub-menus that show UPS, Battery Pack, mains, and load parameter values. These parameters are described below.

Line = xxx.x VAC
Menu Scroll

This screen shows the true rms input line voltage. The accuracy of this measurement is $\pm 5\%$ of the full scale value of 285 Vac.

Output=xxx.x VAC
Menu Scroll

This screen shows the UPS's true rms line-line output voltage. The accuracy of this measurement is $\pm 5\%$ of the full scale value of 285 Vac.

Load = xxx.x %
Menu Scroll

This screen shows the applied load as a percentage of the UPS's full rated capacity. The accuracy of this measurement is $\pm 4\%$ of the full scale value of 105%.

Est run xxx min
Menu Scroll

This screen shows the estimated run time available in minutes. The indication is based on available battery capacity and the applied load. The UPS keeps track of changing battery performance and adjusts the available run time indicated for weak batteries nearing the end of their service life.

Temp= xx.x °C
Menu Scroll

This screen shows the internal temperature of the Electronics Unit in degrees Centigrade. The indicated temperature rises when the UPS is operating on-battery and when the ambient temperature rises.

Battery= xxx.x %
Menu Scroll

This screen shows the available battery capacity as a percent of the fully charged condition.

5.0 Operation

5.2.4 UPS Status menu (continued)

```
Line = xx.xx Hz
Menu      Scroll
```

This screen shows the frequency to which the UPS's output is synchronized (accuracy is $\pm 1\%$ of the full scale value of 63 Hz).

```
# Batt packs: xx
Menu      Scroll
```

This screen shows the number of Battery Packs connected in the system.

```
# Bad batts: xx
Menu      Scroll
```

This screen shows the number of bad or worn Battery Packs connected in the system. To identify the bad Battery Packs, locate the packs having an illuminated Replace Battery indicator.

5.2.5 UPS Diagnostics menu

The UPS Diagnostic menu allows the user to access information that may be useful when troubleshooting the UPS.

```
UPS id: xxxxxxxx
Menu      Scroll
```

This screen shows the UPS's identity name. The name set by the factory can be changed to an 8 character alphanumeric name using optional UPS monitoring application software.

```
UPS SN: xxxxxxxx
Menu      Scroll
```

This screen shows the UPS's serial number set by the factory.

```
UPS MFG xx/xx/xx
Menu      Scroll
```

This screen shows the UPS's date of manufacture set by the factory.

```
Batt: xx/xx/xx
Menu      Scroll
```

This screen shows the date of the last Battery Pack replacement. It is set to the date of manufacture by the factory, but can be updated when new Battery Packs are installed using optional UPS monitoring application software.

```
UPS FW rev: xxM
Menu      Scroll
```

This screen shows the firmware instruction set revision for the Electronic Unit's UPS control microprocessor.

5.0 Operation

5.2.5 UPS Diagnostics menu (continued)

Disp FW rev: xx
Menu Scroll

This screen shows the firmware instruction set revision for the EU's display microprocessor.

Float batt: xx
Menu Scroll

This screen shows the number of Battery Packs reporting that their voltage level has reached the proper "float" voltage.

Batt = xx.xx VDC
Menu Scroll

This screen shows the UPS's battery voltage. The accuracy of this measurement is $\pm 5\%$ of the full scale value of 68 Vdc.

Xfer:xxxxxxxxxx
Menu Scroll

This screen shows the cause of the last transfer to on-battery operation. This information is updated each time the UPS transfers to on-battery.

- If the UPS transferred to on-battery operation because of a mains voltage notch or spike, the display reports the cause as "notch/spike."
- If the UPS transferred to on-battery operation because of an unacceptable rate of change in the output voltage, the display reports the cause as "dV/dt."
- If the UPS transferred to on-battery operation to maintain proper output voltage regulation in response to high or low mains voltage, the display reports the cause as "Hi Line V" or "Lo Line V."
- If the UPS transferred to on-battery operation to conduct battery tests, the display reports the cause as "Self test."

Load amps= xx.xx
Menu Scroll

This screen shows the rms current drawn by the UPS's load in Amps. The accuracy of this measurement is $\pm 5\%$ of the full scale value of 35 Amps.

Load VA pct= xxx
Menu Scroll

This screen shows the Volt-Amps drawn by the UPS's load as a percent of full rated capacity. The accuracy of this measurement is $\pm 5\%$ of the full scale value of 105%.

5.0 Operation

5.2.6 UPS Setup

The UPS Setup menu gives you access to various submenus. Select function choices with the Select key. Access other submenus and confirm choices by pressing the Ok key. The submenus are described below. All submenus are shown with the factory-set function choice.

Note: *The submenus are subject to change—for the latest changes refer to any addendum or errata sheets included with this manual.*

```
Self Test : ON
Menu Select Ok
```

This screen shows the selected UPS self test mode. The self test verifies the readiness of the UPS. This test helps warn you of conditions that could cause unexpectedly short run times.

“ON”—Self test runs immediately at start-up.

“OFF”—Self test function is disabled.

“7 day”—Self test is run automatically at startup and once every 7 days.

“14 day”—Self test is run automatically at startup and once every 14 days thereafter.

```
Snstvtv: Auto
Menu Select Ok
```

This screen shows the mains failure sensitivity setting. The UPS can be set to automatically adapt to mains service where extreme voltage distortion or severe rapid voltage excursions occur. Such conditions may be caused by inexpensive fuel generators, long branch circuits burdened by heavy cyclic loads, nearby arc welding, or heavy industry equipment.

“AUTO”—UPS automatically adapts to mains service quality. Select this to avoid frequent on-battery transfers which could needlessly exercise the battery, shortening its life. Normally, the UPS provides voltage regulation within a narrow band. In response to rapid and frequent mains voltage fluctuations, the UPS relaxes the regulation. This relaxed regulation band remains within the bounds recommended by telecommunications and computer manufacturers. See the Specifications section for the regulation ratings.

5.0 Operation

5.2.6 UPS Setup (continued)

```
Snstvty: Auto
Menu Select Ok
```

“High”—UPS remains sensitive to aberrant line voltages. Load voltage regulation stays within the narrow band.

```
Upper xfer=276 V
Menu Select Ok
```

“Low” or “Medium”—UPS is less sensitive to aberrant voltages. Voltage regulation is relaxed.

The voltage at which the UPS transfers to on-battery operation is adjustable for conditions where high mains voltage persists and it is known that the loads can withstand the elevated voltage.

- When configured for 208V service, the transfer voltage choices are 240V, 244V, 248V and 252V.
- When configured for 240V service, the transfer voltage choices are 276V, 264V, 253V, 282V.

```
LoBatt warn= 2 m
Menu Select Ok
```

The minimum interval between activation of the UPS’s low-battery alarm warnings and UPS shutdown is user configurable.

- The choices are 2, 5, 7 and 10 minutes.

```
Sdown Wndo: NO
Menu Select Ok
```

The UPS may be set to shut down before usable battery capacity is spent. This conserves battery capacity in the event of successive outages.

- The choices for the amount of on-battery run time to be conserved are “NO” (none) and 2, 5, and 8 minutes.

```
Alarm: All imed
Menu Select Ok
```

For applications where the UPS is used as a remote power source or where the UPS frequently transfers to on-battery operation because of poor service quality, the function of the audible alarm may be altered so that it will not become an annoyance.

“All imed”—A sequence of four beeps is sounded immediately upon transfer to on-battery operation. The UPS sounds the beep sequence every 30 seconds while operating on-battery. When low battery conditions are reached, the alarm changes to a beep once every second.

5.0 Operation

5.2.6 UPS Setup (continued)

```
Alarm: All imed
Menu Select Ok
```

“30s dely”—The on-battery audible alarm is disabled for the first 30 seconds of on-battery operation.

“Low Batt”—The audible alarm is disabled during on-battery operation until low-battery conditions are reached.

“Disable”—The audible alarm is disabled during on-battery operation and low-battery conditions.

```
T-off dly= 20 s
Menu Select Ok
```

For computer networks that are unable to issue UPS shutdown commands during the last part of a shutdown routine, the UPS provides a settable shutdown delay interval to allow the network to finish its shutdown routine.

- Shutdown delay choices are 20, 180, 300, and 600 seconds.

```
T-on dly = 0 s
Menu Select Ok
```

You may set a delay interval for energizing the output after return of normal mains voltage, or after a scheduled shutdown. This is useful in applications that require staggered power up of equipment connected at various sources.

- Load power delay choices are 0, 60, 180, and 300 seconds.

```
Set Output=240 V
Menu Select Ok
```

The user may select the UPS’s nominal output voltage to values of 220, 225, 230, or 240 Vac.

```
OutV Report:Auto
Menu Select Ok
```

The UPS’s nominal output voltage can be changed to 208V using optional power distribution plates (also called “PDUs,” contact your dealer or the factory) regardless of whether the input is configured for 208V or 240V service. When an optional PDU is installed, the UPS must be set to report the correct output voltage. When the “Auto” function is chosen, the reported nominal output voltage is scaled according to the input tap selected.

5.0 Operation

5.2.7 UPS Tests

The UPS Tests menu allows the user to access submenus that show operation confirmation functions.

Alarm Test
Menu Do Scroll

This screen shows the audible alarm test sub-menu. When the Do key is pressed, the UPS will briefly sound the audible alarm.

Battery Test
Menu Do Scroll

This screen shows the battery test sub-menu. When the Do key is pressed, the UPS will perform a self test to determine the readiness of the UPS and the batteries to operate the load while on-battery. When conducting this test, the UPS operates on-battery. The UPS does not signal the on-battery condition at the Computer Interface port during this test. The display will report "PASS" or "FAIL" at the end of the test.

Battery Cal Test
Menu Do Scroll

This screen shows the battery run time calibration test sub-menu. To calibrate the UPS's run time display following installation, press the Do key. If the calibration test is not conducted, the UPS provides only a rough estimate of run time until actual battery "statistics" can be acquired during an extended mains failure.

When the Do key is pressed, the UPS will perform the test only if battery capacity is at 100%. The test is completed and the UPS returns to normal on-line operation when the batteries are discharged to approximately 25% of their full capacity. The calibration test can be aborted at any time during the test.

5.2.8 Password protection

All functions accessed by the UPS Control, UPS Setup and UPS Tests menus may be password protected to prevent operation of the unit in a fashion not intended by the UPS manager. The password settings are accessed by optional UPS monitoring application software.

6.0 UPS Monitoring

6.1 Overview

A UPS system provides excellent protection from brief power problems. However, during an extended power outage an unattended computer system will eventually shut down from battery capacity exhaustion. To prevent data corruption when the UPS shuts down, your computer must be informed by the UPS of *impending* shut-down and take appropriate file-saving measures. This is called “UPS monitoring.” The UPS’s Computer Interface port allows your UPS to communicate with a computer system.

Some computer operating systems have built-in UPS monitoring. These systems require various hardware interfaces. Interface kits for all operating systems that support UPS monitoring are available from your dealer. In addition, your dealer also offers PowerChute software which enhances built-in UPS monitoring. Versions of PowerChute are available to add UPS monitoring to operating systems which do not provide it.

6.2 Interface Kits

Interface kits are available for operating systems that provide UPS monitoring. Each kit includes the specific interface cable for converting status signals from the UPS into signals the operating systems recognize. Each kit includes all necessary installation instructions. Systems for which interface kits are offered include Novell, LAN Manager, LANtastic, Banyan VINES, and IBM AS/400.

6.3 PowerChute Software

PowerChute software provides complete data protection for most operating systems. This software is a background process that monitors the UPS through a RS-232 serial port on the host. PowerChute offers user notification of impending shutdown, power event logging, auto-restart upon power return, and UPS battery conservation features. For selected operating systems, PowerChute offers sophisticated power diagnostic and network power management features. These include interactive battery testing; scheduled server shutdowns, reboots and battery testing; detailed power quality logging and a remote, real time, graphic power status display showing UPS loading and battery conditions. PowerChute is available for many platforms including Novell, OS/2, AppleShare, XENIX, most UNIX-based operating systems, and DEC VAX/VMS.

Caution: *Use only factory supplied or authorized UPS monitoring cables!*

6.0 UPS Monitoring

6.4 Computer Interface port

The Computer Interface port is shown below for your reference. Those with technical abilities wishing to use this port in a special application should be aware of the following limitations and capabilities of the interface.

- Outputs at pins 3, 5, and 6 are open collector outputs which must be pulled up to a common referenced supply no greater than +40 Vdc. The transistors are capable of a maximum noninductive load of 25 mAdc. Use only Pin 4 as the common.
- The output at Pin 2 will generate a LO to HI RS-232 level upon transfer of the output load to power derived from the UPS's battery. The pin is normally at a LO RS-232 level.
- The UPS will shut down when a HI RS-232 level, sustained for 4.5 sec., is applied to Pin 1. The UPS responds to this signal, following a delay, only during mains failures (on-battery operation).
- An unregulated +24 Vdc appears at Pin 8 of the interface port whenever the UPS is powered. The supply is limited to 40 mAdc maximum.

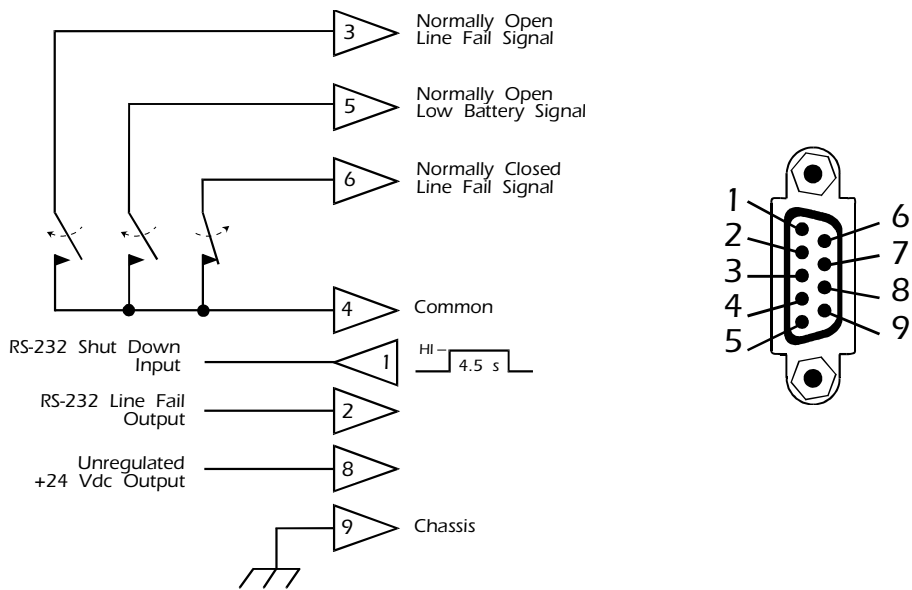



CAUTION!

- This Uninterruptible Power Source contains potentially hazardous voltages. Do not attempt to disassemble the unit. The unit contains no user serviceable parts. Repairs are performed only by factory trained service personnel.
- This Uninterruptible Power Source uses batteries. The batteries will eventually become too weak to provide rated autonomous operation. Due to the potential health and environmental hazards posed by the batteries, they may be replaced only at factory authorized Service Centers. To obtain battery replacement or repair service, please call the Customer Service telephone number written on the cover of this manual for information on the Service Center nearest you.



- **The batteries used by this Uninterruptible Power Source are recyclable. Proper disposal of the batteries is required. The batteries contain lead and pose a hazard to the environment and human health if not disposed of properly. Please refer to local codes for proper disposal requirements or return the unit to a factory authorized Service Center for battery replacement or disposal.**
- Battery replacement should be performed or supervised by personnel familiar with the danger of batteries and the required precautions. Keep unauthorized personnel away from batteries. When replacing batteries, use the same number and type of sealed lead acid batteries as were originally contained in your UPS.
- **CAUTION**—Do not dispose of batteries in a fire. The batteries may explode.
- **CAUTION**—Do not open or mutilate batteries. They contain an electrolyte which is toxic and harmful to the skin and eyes.
- **CAUTION**—A battery can present a risk of electrical shock and high short circuit current. When replacing batteries, wrist watches and jewelry such as rings should be removed. Use tools with insulated handles.



ATTENTION!

- Cette source d'alimentation permanente (UPS) contient des circuits haute tension présentant un danger. Ne jamais essayer de le démonter. Il n'y a aucun composant qui puisse être réparé par l'utilisateur. Toutes les réparations doivent être effectuées par du personnel qualifié et agréé par le constructeur.
- Cette source d'alimentation permanente (UPS) contient des accumulateurs. Ces accumulateurs deviendront un jour trop faibles pour pouvoir assurer un fonctionnement autonome correct. En raison des risques que posent les accumulateurs à la santé et à l'environnement, ils ne peuvent être remplacés que dans les Centres de Service agréés par le fabricant. Pour toute réparation ou remplacement des accumulateurs, composez le numéro du Service à la clientèle inscrit sur la couverture de ce manuel afin d'obtenir les coordonnées du Centre de Service le plus proche.



- **Les accumulateurs contenus dans cette source d'alimentation sont recyclables. L'élimination des batteries est réglementée. Consulter les codes locaux à cet effet. Ils contiennent du plomb et représentent donc un risque pour l'homme et pour l'environnement si les règles de mise au rebut ne sont pas respectées. Veuillez retourner l'unité à un Centre de Service agréé lorsque vous désirez remplacer ou vous débarrasser des accumulateurs usagés.**
- **ATTENTION**—Pour le remplacement, utiliser le même nombre de batteries du modèle suivant: accumulateur au plomb.
- **ATTENTION**—Une batterie peut présenter un risque de choc électrique, de brûlure par transfert d'énergie. Suivre les précautions qui s'imposent.



VORSICHT!

- Im Inneren dieser unterbrechungsfreien Stromversorgung herrschen potentiell gefährliche Spannungen. Nicht versuchen, das Gerät zu öffnen. Es enthält keine vom Benutzer reparierbaren Teile. Reparaturen dürfen nur von ausgebildetem Kundendienstpersonal durchgeführt werden.
- Diese unterbrechungsfreie Stromversorgung enthält Batterien, die nach einer bestimmten Zeit so schwach werden, daß der autonome Nennbetrieb nicht mehr gewährleistet ist. Aufgrund der potentiellen Gesundheits- und Umweltgefahren, die von den Batterien ausgehen, dürfen sie nur in einem vom Werk autorisierten Kundendienstzentrum ausgewechselt werden. Wenn die Batterien ausgewechselt werden müssen oder Reparaturen fällig sind, die auf der Umschlagseite dieser Gebrauchsanweisung angegebene Kundendienst-Telefonnummer anrufen. Dort teilt man Ihnen mit, welches Kundendienstzentrum für Sie zuständig ist.



- **Die Batterien in dieser unterbrechungsfreien Stromversorgung sind wiederverwertbar. Sie sind bleihaltig und stellen eine Gefahr für die Umwelt und die Gesundheit dar, wenn sie nicht ordnungsgemäß entsorgt werden. Das Gerät an ein vom Werk autorisiertes Kundendienstzentrum einsenden, um die Batterien auswechseln oder entsorgen zu lassen.**



¡ATENCIÓN!

- Esta Fuente de energía ininterrumpible contiene niveles de voltaje peligrosos en potencia. No intente desarmar la unidad, pues no contiene piezas que puedan ser reparadas por el usuario. Las reparaciones deben efectuarse únicamente por parte del personal de mantenimiento capacitado en la fábrica.
- Esta Fuente de energía ininterrumpible contiene baterías. Con el tiempo las baterías se gastan demasiado para poder sustentar el funcionamiento autónomo a la capacidad nominal. Debido a que presentan un peligro potencial para la salud y el medio ambiente, las baterías pueden reemplazarse únicamente en los Centros de Servicio autorizados por la fábrica. Para solicitar el reemplazo de baterías o servicio de reparaciones, se ruega llamar al número telefónico de Atención a los Clientes indicado en la tapa de este manual y averiguar el Centro de Servicio más cercano.



- Las baterías que se encuentran en esta Fuente de energía ininterrumpible son reciclables. Las baterías contienen plomo y constituyen un peligro para el medio ambiente y para la salud de las personas si no se las desechan como corresponde. Se ruega devolver la unidad a un Centro de Servicio autorizado por la fábrica para el reemplazo o la eliminación de las baterías.

7.0 Difficulty

7.1 Troubleshooting Chart		
Problem	Possible Cause	Action to Take
UPS will not turn on.	The UPS's input circuit breaker is tripped (1/2 of handle is down).	Reduce the load on the UPS by unplugging equipment and reset the circuit breaker.
	EU separating screw is loose.	Tighten the EU separating screw (do not overtighten).
	Circuit closure present at the Emergency Power Off interface.	Check the EPO connections. See section 4.7.
UPS operates on-battery even though normal utility voltage is thought to exist.	Very high line voltage.	Test the line voltage with the UPS voltage meter (see section 5.2.4). If necessary, adjust the UPS upper transfer voltage (see section 5.2.5).
	Highly distorted line voltage.	Inexpensive fuel powered generators can cause distorted line voltages. Desensitize the UPS to the distortion (see section 5.2.5).
UPS beeps occasionally.	This is normal.	None. The UPS is protecting the loads.
UPS does not provide expected back up time.	The UPS's batteries are discharged from recent utility outage.	None. The UPS's batteries require recharging after extended or successive outages.
	The UPS's batteries are weak due to age or wear.	The batteries wear faster when put into service often and when operated at elevated temperatures.
UPS display shows "No Battery Communication".	One or more battery pack cables is not properly connected.	Check connections to and from each battery pack and the EU. See section 4.6.
UPS display shows "In Bypass Mode Press Any Key".	Battery pack coupler not properly mated with the EU coupler.	Check battery pack connections. See section 4.10.
	Input circuit breaker cycled on-off-on too quickly.	Follow display prompts to return to normal on-line operation.
UPS display shows "UPS in BYPASS chk rear switch"	The manual bypass switch at the rear of the EU is in the bypass position.	Change the switch setting to resume normal on-line operation.
Output voltage reading incorrect after installation of a new power distribution plate.	Output voltage reporting incorrectly set.	Change the output voltage reporting setup. See section 5.2.6.
Output voltage outside rated regulation band.	Upper transfer voltage set higher than the factory setting.	If necessary, change the upper transfer voltage setting. See section 5.2.5.
	The UPS has relaxed load voltage regulation to compensate for distorted or fluctuating utility voltage.	Set the UPS's utility failure sensitivity to "High" to maintain narrow band regulation. See section 5.2.5.
The UPS does not power the load immediately following the return of normal utility voltage.	The turn on delay set to a non-zero value.	Set the turn on delay to the desired value. See section 5.2.6.

7.0 Difficulty

7.2 Fault messages

The UPS displays one of the following screens when it detects an internal fault. See Section 7.5 which covers obtaining service.

7.2.1 Replace Electronics Unit (EU)

DC imbalance
call for service

A DC imbalance fault results in bypass operation—load power is lost during a mains failure.

WARNING!
UPS too Hot!

Overheating of the EU results in bypass operation—load power is lost during a mains failure.

Top fan fault
UPS on battery

Failure of either EU fan while operating on-battery may cause overheating within the EU. Overheating while on-battery will result in the loss of load

Top fan fault
UPS in bypass

power. Failure of either fan while operating on-line will result in bypass operation—load power may be lost during a mains failure.

Battery charger
has failed!

A battery charger fault results in bypass operation—load power is lost during a mains failure.

Main relay fault
call for service

A main relay fault results in loss of load power. Remove the EU to resume load power in bypass mode—load power is lost during a mains failure.

7.2.2 UPS requires service

Bottom fan fail
call for service

The UPS may remain operating when this IU fan fault message is encountered. Schedule UPS service when convenient.

Aux Pwr Sup Fail
call for service

Do not attempt manual bypass operation when this fault message is encountered as load power will be lost. Schedule UPS service when convenient.

Out V selct fail
call for service

If the input voltage tap configuration has been changed, a qualified technician should reinspect the connections—see Section 4.8. An output voltage select fault results in bypass operation—load power is lost during a mains failure.

Bypass rly fault
call for service

A bypass relay fault will result in permanent bypass operation—load power is lost during a mains failure.

7.0 Difficulty

7.3 Replacing the Electronics Unit

The UPS allows replacement of a failed Electronics Unit without interruption of power to the load. The Isolation Unit is capable of autonomous operation and provides power to the load isolated from EMI/RFI noise and surges.

To replace a failed EU, follow the procedures listed below.

7.3.1 Put the UPS into the bypass mode of operation by actuating the manual bypass switch at the rear of the EU. **Note:** Transfers to bypass mode using the manual bypass switch occur within 10 mS typically. The transfer back from the bypass mode occurs in 0 mS.

7.3.2 Using a coin or large flat blade screwdriver, unscrew the EU separating screw and pull back.

7.3.3 Using a phillips screwdriver, loosen the Battery Pack coupler lock at the rear of the EU and disconnect the pack coupler. Disconnect the Battery Pack communications cable from the jack at the rear of the EU.

7.3.4 If necessary, disconnect cables connected at the Computer Interface port and the Emergency Power Off interface.

7.3.5 Grasp the EU at the slots shown in the illustration and pull straight up and away from the IU.

7.3.6 Follow the above procedures in reverse to install the replacement EU. Once the replacement EU is installed, press any key to regain control of the UPS.

Note: Do not grasp the EU by the display and control panel.

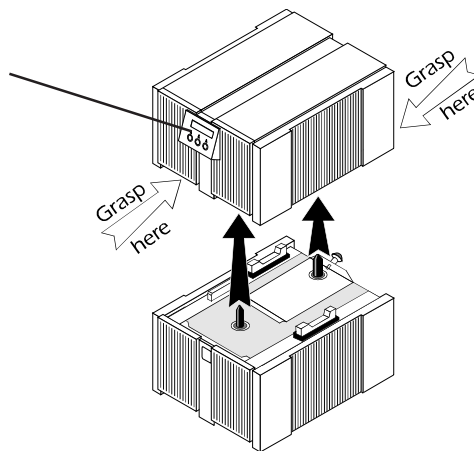

7.0 Difficulty

7.4 Replacing or adding Battery Packs

You can expect to receive 3 to 6 years of service life from the Battery Packs when installed in a cool, dry location. The Battery Pack's life is shortened when operated in an environment where the ambient temperature is normally above 30°C (86°F).

Battery packs
Need Replacement

The Electronics Unit will display this message when any one of the connected Battery Packs requires replacement. Battery Packs that can no longer sustain a charge are identified by an illuminated Replace Battery indicator.

Battery Packs can be added or replaced at any time, regardless of mode of operation. See the procedures listed below to replace a worn Battery Pack.

Caution: *If the first Battery Pack in the string (connected directly to the Electronics Unit) is replaced, the UPS will not be able to support the load in the event of a mains failure during the time that the battery string is uncoupled from the EU. Always place the UPS in bypass when this Battery Pack is replaced.*

7.4.1 Disconnect both INPUT and OUTPUT battery communications cables connected at the worn Battery Pack.

7.4.2 Remove the clamps securing the in-line coupler and panel coupler (if necessary) at the worn Battery Pack.

7.4.3 Unmate the couplers at the worn Battery Pack and return it to the factory for recycling.

7.4.4 If necessary, remove the panel coupler clamp. Set the new Battery Pack in place.

7.4.5 Mate the in-line and panel couplers on the new Battery Pack.

7.4.6 Secure the couplers with the coupler clamps.

7.4.7 Plug-in the battery communications cables at the new Battery Pack. See the illustration in Section 4.10.6.

Number Battery
Packs Changed!

Note: *Always check the number of Battery Packs reported by the UPS (UPS Status menu) after adding or replacing Battery Packs.*

** No Battery **
Communications

Note: *If this fault message is encountered, check the communications cables to, and from each Battery Pack—see Section 4.10.6.*

7.0 Difficulty

7.5 Obtaining Service

The troubleshooting chart in Section 7.1 covers most of the difficulties that a user may encounter under conditions other than a failure of the UPS itself. For problems not covered in the chart, or when the UPS's display shows "call for service," the procedures outlined below should be followed.

If your UPS should require service:

■ See the troubleshooting chart and eliminate the obvious. **A tripped UPS circuit breaker is the most common problem encountered and is user-resettable once excessive loads are unplugged from the UPS.**

■ If the circuit breaker is OK, note your UPS model, serial number and date of purchase. Contact the Customer Service Department at the phone number given on the cover of this booklet.

■ Be prepared to provide a description of the problem. A technician will help you solve the problem over the phone if possible, or will give you a Return Material Authorization Number (RMA#).

■ If the UPS is within the warranty period, repairs will be performed free of charge. If it is not within the warranty period, there will be a charge for repair.

■ Pack the UPS in its original packaging. *If you no longer have the original shipping materials, ask the technician about obtaining a new set.* It is very important that you pack the UPS properly to avoid damage in transit. Never use styrofoam beads for packaging a Battery Pack or Electronics Unit because they will settle through beads and become damaged. Damages sustained in transit are not covered under warranty. Enclose a letter in the package with your name, RMA#, address, copy of sales receipt, description of trouble, phone number and check (if necessary).

■ Mark your RMA# on the outside of the package. *The factory cannot accept any package without this marking.*

■ Return your UPS by insured, prepaid carrier to the address on the rear of this manual.

Tripped !



8.0 Storing the UPS

8.1 Storage conditions

The UPS should be covered and stored in a cool dry location. The UPS should be stored with the Battery Packs in a fully charged state. That is, the reported battery capacity should be at 100% before the UPS is switched off for storage.

Disconnect any accessories or cables connected to the Computer Interface port—such devices may unnecessarily drain the batteries.

Disconnect the battery packs from the UPS and each other (if applicable). Store the battery packs in an upright position.

8.2 Extended storage

To achieve expected run time following extended storage, the UPS should be allowed to refresh the Battery Packs every 6 months in environments where the ambient temperature is -15°C to $+30^{\circ}\text{C}$ (5°F to 86°F). For extended storage in environments where the ambient temperature is $+30^{\circ}\text{C}$ to $+45^{\circ}\text{C}$ (86°F to 113°F), the UPS should be allowed to refresh the Battery Packs every 3 months.

9.0 Specifications

Note: Where different, values for 208 Vac operation are given in brackets [].

9.1 Input

Nominal input voltage: single phase 240 Vac [208 Vac].

Nominal input frequency: 50 or 60 Hz.

On-line efficiency at full load: > 93% with fully charged batteries.

Input circuit breaker: 20 Amp (3000VA model), 30 Amp (5000VA model).

Input voltage selection: tap selected.

9.2 Transfer Characteristics

Frequency limits (on-line): 47 to 63 Hz.

Input voltage limits (on-line): -25 to +15% of the nominal input voltage.

Transfer to/from on-battery: 0 ms typical with computer loads, 1.5 ms maximum.

Transfer is synchronous with mains voltage phase.

Transfer to/from bypass: Transfers to and from bypass occur synchronously with the utility voltage phase. Transfers both to and from bypass mode typically occur in 0 mS.

9.3 Output Characteristics

Maximum load: 3000 VA or 2250 W at 0.75 power factor (3000 VA model); 5000 VA or 3750 W at 0.75 power factor [4700 VA or 3750 W at 0.8 power factor] (5000VA model).

Nominal output voltage: 240 Vac; may be user set to 220, 225, or 230 Vac.

On-line voltage regulation: $\pm 5\%$. User-selected "Auto" or "Low" sensitivity may relax output voltage regulation to +5%, -12%.

On-line frequency regulation: Synchronized to the mains.

On-battery output voltage regulation: $\pm 5\%$.

On-battery output frequency regulation: 50 or 60 Hz, ± 0.1 Hz unless synchronized to mains frequency during utility brownout.

On-battery output voltage total harmonic distortion: < 5%.

Protection: overcurrent & short circuit protected, latching shutdown on overload.

Output connections: (8) IEC 320 C13 business appliance receptacles.

9.4 Noise and surge isolation

Isolation: galvanic isolation, output neutral bonded to ground.

Normal mode EMI/RFI noise attenuation: 40-60 dB over 100 kHz to 30 MHz.

Common mode EMI/RFI noise attenuation: 40-60 dB over 100 kHz to 30 MHz.

Normal mode let-through: $\leq 0.7\%$ of applied ANSI C62.41 Cat. A or B ± 6 kV test.

Common mode let-through: $\leq 1.0\%$ of applied ANSI C62.41 Cat. A or B ± 6 kV test.

9.0 Specifications

9.5 Battery Pack

Battery type: spill proof, maintenance free sealed lead-acid.

Nominal battery pack voltage: 48 Vdc.

Typical battery life: 3 to 6 years (depends upon number of discharge cycles and normal ambient temperature).

Recharge time: see table in Section 9.9.

Max. number of Battery Packs: limited only by desired recharge time.

9.6 Environment

Operating temperature: 0°C to 40°C (32°F to 104°F).

Storage temperature: -15°C to 45°C (5°F to 113°F).

Operating and storage relative humidity: 0 to 95%, non-condensing.

Operating elevation: 0 to 3,000 m (10,000 ft)

Storage elevation: 0 to 15,000 m (50,000 ft)

Electromagnetic immunity: IEC 801-2, 801-3, 801-4, 801-5; severity level III or IV.

Audible noise: < 55 dBA at 1 m (3 ft).

9.7 Physical

UPS dimensions (EU and IU mated): 17.8 H x 13.8 W x 17.8 D in.
(45.2 x 35.1 x 45.2 cm).

Battery pack dimensions: 9.1 H x 6.9 W x 17.8 D in. (23.1 x 17.5 x 45.2 cm).

UPS weight (EU and IU mated): 153 lb (69.4 kg), 191 lb (86.6 kg) for the 3000VA and 5000VA models, respectively.

Electronics Unit (EU) weight: 40 lb (18.1 kg), 45 lb (20.4 kg) for the 3000VA and 5000VA models, respectively. Add 8 lbs (3.6 kg) for shipping independent of IU.

Battery pack weight: 64 lbs (29.0 kg). Add 5 lbs (2.3 kg) for shipping independent of UPS.

Total shipping weight—3000VA model: 256 lb (116.1 kg). Includes weight of packaging, mated EU and IU, cords, and one (1) Battery Pack.

Total shipping weight—5000VA model: 363 lb (164.6 kg). Includes weight of packaging, mated EU and IU, cords, and two (2) Battery Packs.

Color: beige.

9.8 Approvals

Safety approvals: UL per 1778, CSA per C22.2., TUV per IEC 950

EMC verification: FCC, CDC, EN55022 Class A verified.

Typical On-Battery Run Time Versus Load, 3000 VA Matrix-UPS with SmartCells, in Hours								
	Number of SmartCells							
Computer Load (VA)	1	2	3	4	5	6	7	8
250	3.07	7.20	11.56	15.93	20.29	24.65	29.02	33.38
500	1.46	3.52	5.80	8.24	10.69	13.13	15.57	18.01
1000	0.57	1.46	2.46	3.52	4.58	5.80	7.02	8.24
1500	0.33	0.83	1.46	2.11	2.81	3.52	4.23	4.99
2000	0.22	0.57	0.99	1.46	1.93	2.46	2.99	3.52
2500	0.17	0.46	0.78	1.18	1.59	1.99	2.45	2.90
3000	0.13	0.36	0.62	0.92	1.25	1.59	1.92	2.30
	Recharge Time, in Hours							
	1.2	2.8	2.7	3.8	4.9	6	7	8.1
Calculations based on loads with a .75 power factor. Lower power factor loads will yield higher run times. Run times are typical at 25° C (77° F). Recharge times to 90% of rated capacity after discharge into 50% of rated load.								

Typical On-Battery Run Time Versus Load, 5000 VA Matrix-UPS with SmartCells, in Hours								
Computer Load (VA)	Number of SmartCells							
	2	3	4	5	6	7	8	
500	3.07	5.02	7.20	9.38	11.56	13.75	15.93	
1000	1.46	2.46	3.52	4.58	5.80	7.02	8.24	
1500	0.83	1.46	2.11	2.81	3.52	4.23	4.99	
2000	0.57	0.99	1.46	1.93	2.46	2.99	3.52	
2500	0.46	0.78	1.18	1.59	1.99	2.45	2.90	
3000	0.36	0.62	0.92	1.25	1.59	1.92	2.30	
4000	0.24	0.42	0.62	0.83	1.08	1.33	1.59	
5000	0.17	0.31	0.46	0.62	0.78	0.98	1.18	
Recharge Time, in Hours								
	2.8	2.7	3.8	4.9	6	7	8.1	
<p>The case of one SmartCell does not apply to 5000 VA Matrix-UPS. Calculations based on loads with a .75 power factor. Lower power factor loads will yield higher run times. Run times are typical at 25° C (77° F). Recharge times to 90% of rated capacity after discharge into 50% of rated load.</p>								

Typical On-Battery Time Versus Load, 3000 VA Matrix-UPS with SmartCell XR Battery Packs, in Hours								
Number of SmartCell XR Battery Packs								
Computer Load (VA)	1	2	3	4	5	6	7	8
1000	3	6.75	10.75	14.75	18.75	22.75	26.75	30.75
1500	1.8	4.3	6.9	9.5	12.1	14.7	17.3	19.9
2000	1.2	3	5	7	9	11	13	15
2500	0.9	2.4	4	5.6	7.2	8.8	10.4	12
3000	0.75	1.8	3.25	4.7	6.15	7.6	9.05	10.5
Recharge Time, in Hours								
	3.8	8.1	12.5	16.9	21.3	25.7	30.1	34.5
Calculations based on loads with a .75 power factor. Lower power factor loads will yield higher run times. Run times are typical at 25° C (77° F). Recharge times to 90% of rated capacity after discharge into 50% of rated load.								

Typical On-Battery Time Versus Load, 5000 VA Matrix-UPS with SmartCell XR Battery Packs, in Hours								
Number of SmartCell XR Battery Packs								
Computer Load (VA)	1	2	3	4	5	6	7	8
1000	3	6.75	10.75	14.75	18.75	22.75	26.75	30.75
1500	1.8	4.3	6.9	9.5	12.1	14.7	17.3	19.9
2000	1.2	3	5	7	9	11	13	15
2500	0.9	2.4	4	5.6	7.2	8.8	10.4	12
3000	0.75	1.8	3.25	4.7	6.15	7.6	9.05	10.5
4000	0.53	1.25	2.25	3.25	4.25	5.25	6.25	7.25
5000	0.37	0.9	1.6	2.4	3.2	4	4.8	5.6
Recharge Time, in Hours								
	3.8	8.1	12.5	16.9	21.3	25.7	30.1	34.5
Calculations based on loads with a .75 power factor. Lower power factor loads will yield higher run times. Run times are typical at 25° C (77° F). Recharge times to 90% of rated capacity after discharge into 50% of rated load.								

DECLARATION OF CONFORMITY

Application of Council Directive(s): 89/336/EEC

Standard(s) to which Conformity is Declared: EN55022, EN50082-1

Manufacturer's Name: AMERICAN POWER CONVERSION

Manufacturer's Address: 132 FAIRGROUNDS ROAD
WEST KINGSTON, RI 02892 USA

Importer's Name: _____

Importer's Address: _____

Type of Equipment: UNINTERRUPTIBLE POWER SOURCE

Model No.: MATRIX 3000, 5000

Serial Number: P950100001 - P951299999

Year of Manufacture: 1995

I, the undersigned, hereby declare that the equipment specified above conforms to the above Directives(s).

Place: BILLERICA, MA USA

(Signature)

Date: 1/1/95

Joseph Pomata

(Full name)

Regulatory Compliance Engineer

(Position)



AMERICAN POWER CONVERSION

Toll free technical support:

United States and Canada 1-800-800-4272
 Ireland 1-800-702000
 U. K. 0800-132990

In areas without toll free numbers, call:

+1 401 789 5735 (USA) or
 +353 91 702020 (Ireland)

Return shipment addresses:

American Power Conversion Corporation
 132 Fairgrounds Road
 P. O. Box 278
 West Kingston, Rhode Island 02892
 USA

American Power Conversion Corporation
 (A. P. C.) b. v.
 Ballybritt Business Park
 Galway
 Ireland

Please note: Before calling customer service, please have available your UPS's serial number (see label at the rear of the unit).

Serial Numbers

UPS: _____

Isolation Unit: _____

Electronics Unit: _____

SmartCell #__: _____

SmartCell #__: _____

SmartCell #__: _____

SmartCell #__: _____

SmartCell #__: _____

SmartCell #__: _____

SmartCell #__: _____

SmartCell #__: _____

Entire contents copyright © 1994 American Power Conversion. All rights reserved; reproduction in whole or in part without permission is prohibited. Matrix UPS, SmartCell, and SNMP Adapter are trademarks of APC. PowerChute and PowerDoctor are registered trademarks of APC. All other trademarks are the property of their respective owners.